

PROFIL ALU 40x200 S

KODA NAROČANJA: **9263**
ORDER CODE:

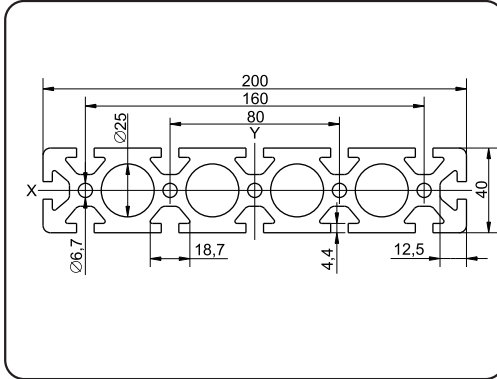
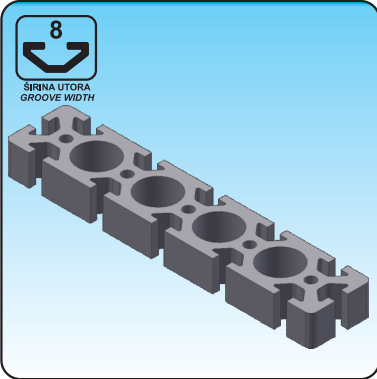

Konstruktivski podatki
Construction specifications:

$m = 10,52 \text{ kg/m}$
 $A = 30,87 \text{ cm}^2$
 $I_x = 66,71 \text{ cm}^4$
 $W_x = 33,36 \text{ cm}^3$
 $I_y = 1386,00 \text{ cm}^4$
 $W_y = 138,60 \text{ cm}^3$

	12000	-	17000

PROFIL ALU 80x80 L

KODA NAROČANJA: **36434**
ORDER CODE:

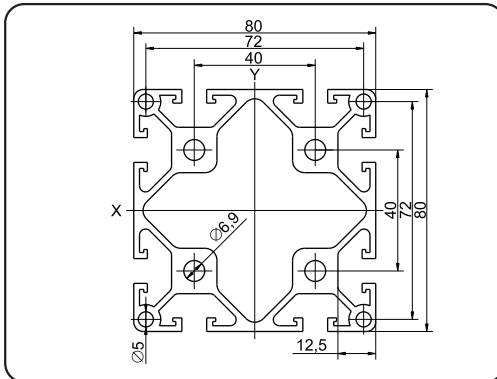
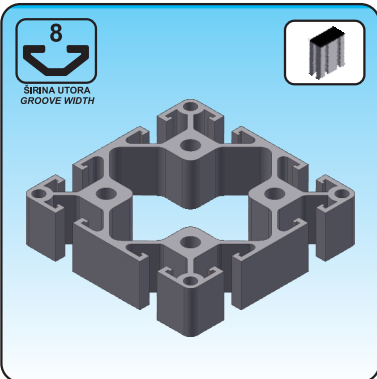

Konstruktivski podatki
Construction specifications:

$m = 4,23 \text{ kg/m}$
 $A = 15,99 \text{ cm}^2$
 $I_x = 109,32 \text{ cm}^4$
 $W_x = 2,73 \text{ cm}^3$
 $I_y = 109,32 \text{ cm}^4$
 $W_y = 2,73 \text{ cm}^3$

	7000	-	12000

PROFIL ALU 80x80 N

KODA NAROČANJA: **46101**
ORDER CODE:

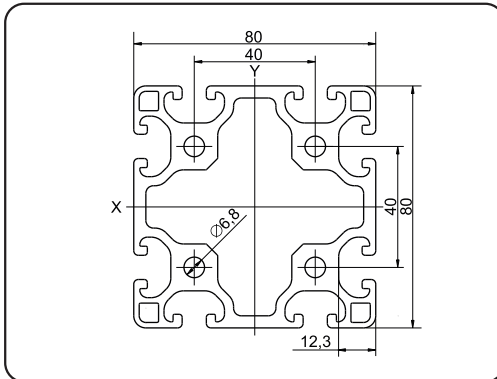
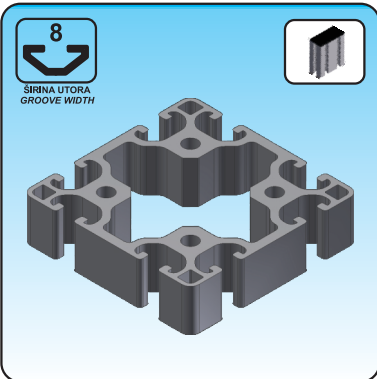

Konstruktivski podatki
Construction specifications:

$m = 5,34 \text{ kg/m}$
 $A = 19,79 \text{ cm}^2$
 $I_x = 135,07 \text{ cm}^4$
 $W_x = 33,77 \text{ cm}^3$
 $I_y = 135,07 \text{ cm}^4$
 $W_y = 33,77 \text{ cm}^3$

	10000	-	16000

PROFIL ALU 80x80 S

KODA NAROČANJA: **36078**
ORDER CODE:

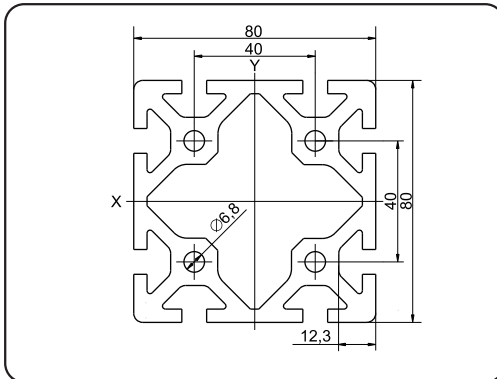
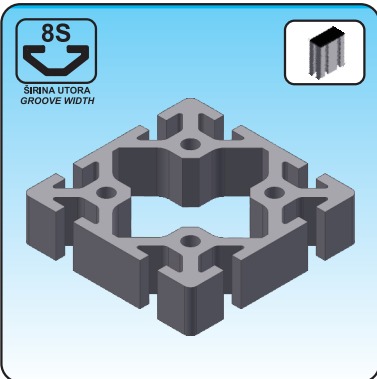

Konstruktivski podatki
Construction specifications:

$m = 6,70 \text{ kg/m}$
 $A = 24,74 \text{ cm}^2$
 $I_x = 179,62 \text{ cm}^4$
 $W_x = 44,90 \text{ cm}^3$
 $I_y = 179,62 \text{ cm}^4$
 $W_y = 44,90 \text{ cm}^3$

	12000	-	17000

KODA NAROČANJA: **46157**
ORDER CODE:

PROFIL ALU 80x160 N

Konstruktivski podatki
Construction specifications:

m = 10,08 kg/m
A = 37,32 cm²
I_x = 266,09 cm⁴
W_x = 66,52 cm³
I_y = 903,76 cm⁴
W_y = 112,97 cm³

	10000	-	16000

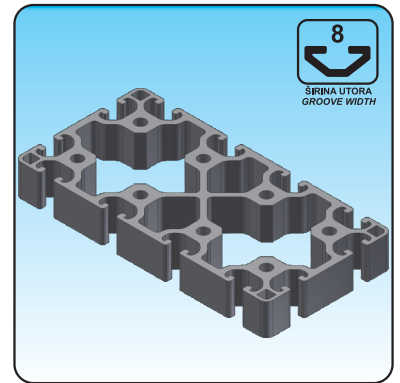
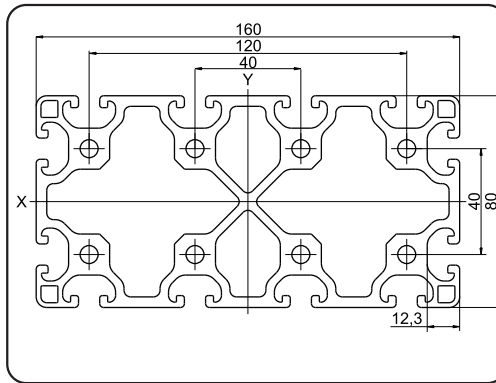

KODA NAROČANJA: **49288**
ORDER CODE:

PROFIL ALU 80x160 S

Konstruktivski podatki
Construction specifications:

m = 13,49 kg/m
A = 49,95 cm²
I_x = 361,68 cm⁴
W_x = 90,42 cm³
I_y = 1228 cm⁴
W_y = 153,50 cm³

	12000	-	17000

